

## Exploration of the Possibility of Acoustic Emission Technique in Detection and Diagnosis of Bubble Formation and Collapse in Valves

Taihret Alhashan<sup>1</sup>, Abdulmajid Addali<sup>2</sup> and Joao Teixeira<sup>3</sup>  
<sup>1,2,3</sup> School of Engineering, Cranfield University, Cranfield, Beds. MK43 0AL.

**Abstract:** The application of acoustic emission (AE) technique in detection and monitoring of bubble formation and collapse in valves are presented in this review. The generation of AE signals and the basic compositions of AE detection system are briefly explained. The applications of AE technique in valves are focused on condition monitoring and detection bubble formation (bubble cavitation), and leakage of water through valves. All results prove that the AE technique works well for detection and diagnosis of failures during valves.

### I. Introduction

The valves play a significant role in industrial worlds such as the nuclear power plant, control of water and gas and oil pipelines. When the valves area failure, the big problems will happen such as environmental pollution, waste of resources, decrease the life of equipment and increase in the maintenance costs [1][2]. The researchers have found that one main type of failure of valves is the liquid leakage caused by sealing surface failure[3]. Furthermore, cavitation phenomena in valves are also interesting. Some techniques have been used to detect and diagnose leakage of a valve such as the shock pulse method, acoustic emission (AE), ultrasonic leak detection and vibration method[4]. It is known that the AE technique for monitoring of materials under stress. Recently, the application of AE technique in the non-destructive detection of valves was developed greatly[5]. The AE technique can monitor and detect the leakage without dismantling valves [4].

### II. The Acoustic Emission (AE) in Valves

AE signal has been found in the process of the fluid leakage such as valve leakage[6]. El-Shorbagy found the measurement of flux rate and automatic online control can be achieved during monitoring and detection the noise level of valve[7]. Sharif and Grovenor noted that the experiment on the leakage of compressed air during control valve and analysed the frequency spectrum of the AE signal. Obtained results explain that the frequency components related to leakage can be picked up from AE signal with background noise [8]. Lee et al. Found the AE characteristic of ball valve leakage under a situation of several leakage modes, and it can be seen that the leakage rate of valves direct proportion with sound amplitude[9]. AE technique can be used in the internal leakage detection and monitoring of valves. Figure 1 shows estimate process of leakage rate.

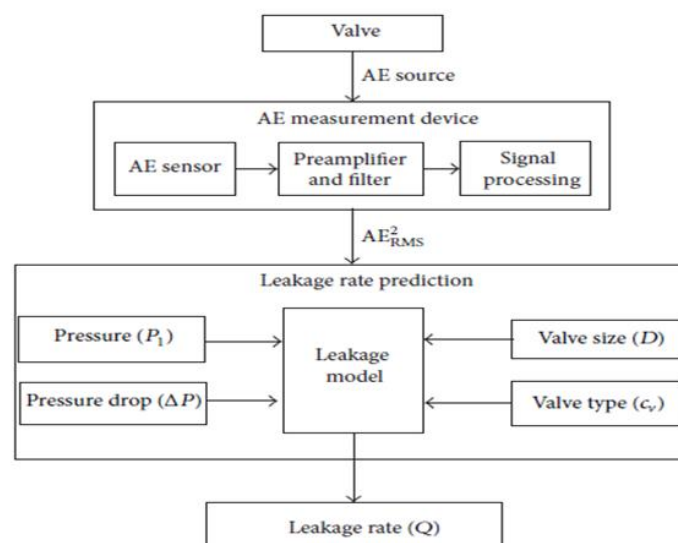

**Figure 1:** Processes to Predict Valve Leakage Rate by Acoustic Emission [10].

### III. Mechanism of Acoustic Emission

Acoustic Emission is a non-destructive test (NDT) method that tests or monitors dynamic materials in real time and so is effective only when the material start tested is loaded or stressed. Commonly, these stresses are transferred to other parts of the structure. Kaiser and Felicity investigated and defined loaded material behaviour.

#### 3.1. Kaiser Effect:

In 1995, Wilhelm Kaiser found that sound waves are released from a loaded material only after any previous maximum load level is exceeded. When the load rises from point A to point B, generates an emission. However, there is no release when the load is decreased, from point B to point C. Furthermore, when the load is increased again, from point C to point B, there is no emission until after point B, emission starts again. See figure 2[11].

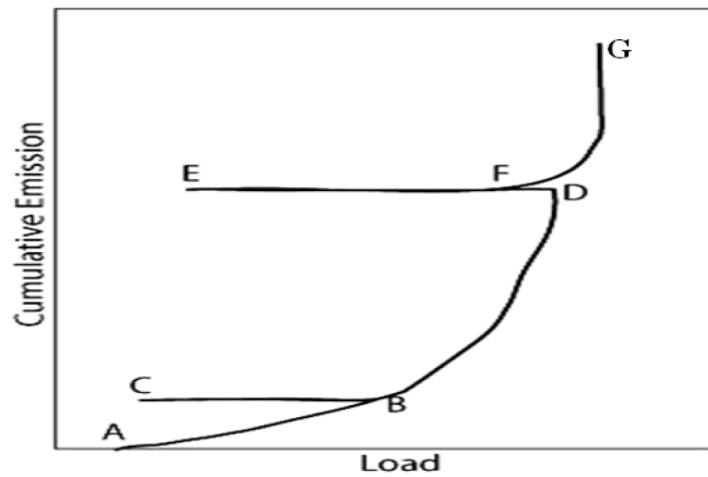

Figure 2: Kaiser and Felicity Effects[11].

#### 3.2. Felicity Effect:

Figure 2 shows that when the load is reduced from point D to point E, there is no emission, and when the load is increased, there is no emission up to the load point F where point F is less than point D.

### IV. The Processing Mechanism of Acoustic Emission Signal

#### 4.1. AE Signal Parameters:

Figure 3 shows the typical signal of Acoustic Emission. The most widely used to explain the AE signal are:

- Threshold: It is a voltage level signal, only signals with amplitudes greater than this will be recognized.
- Arrival Time: It refers to the time of the first crossing of the signal. This parameter is used to determine source locations.
- Rise Time: It is the time duration when the signal first time is crossing threshold and peak amplitude.

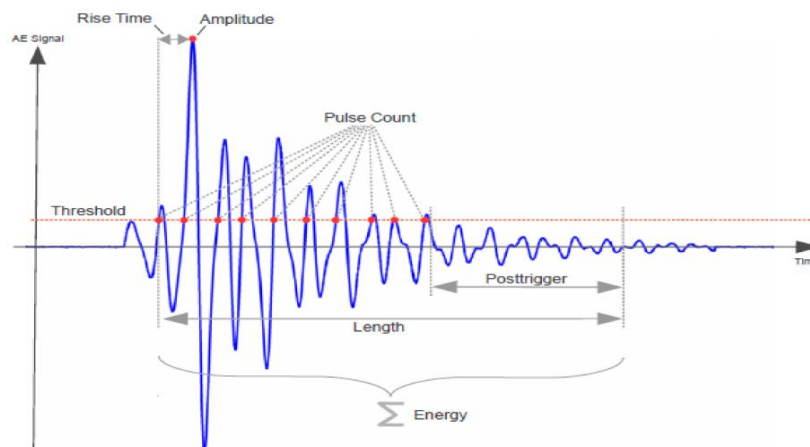

**Figure 3:** Typical Acoustic Emission Signal[12].

- Amplitude (peak amplitude): It is the largest voltage within the duration of the signal.
- Duration: It is the time interval between first and last threshold crossing in the burst signal.
- Counts: It is the number of pulses that cross the predetermined threshold.

Furthermore, root means square (RMS) value, kurtosis, average signal level (ASL). Two parameters, the effective voltage RMS and ASL, are used to describe the AE signal [4]. Kaewwaewnoi et al. found that a good relation existed between the leakage rate and the ASL [13]. Chen et al. noted that the RMS value was more suitable to interpret AE signals generated by internal leakage [14]. Kaewwaewnoi et al. also found the relationship between the AE-RMS and the parameters such as upstream pressure levels, valve sizes, and type of valves (globe, ball and butterfly valves). The AE-RMS can be used to forecast of the leakage rate [10][15]. Gao et al. found the relationship between the valve leakage rate of coal-fired power plants and the AE-RMS. Its accuracy was proved by the practice results [16].

#### **4.2. The New Analysis Methods of AE Signals:**

Recently, with the development of technology in the industrial world, many new signal processing methods are suggested and applied on different fields. To find the useful information from the AE signals, there are some methods used, such as fast Fourier transform (FFT), wavelet transform (WT), and Hilbert-Huang transform (HHT) [17]. Lu et al. found the effectiveness of time-frequency analysis of the AE signals by the tension tests of carbon fibre reinforced plastic (CFRP) composites, where short-time Fourier transform (SFT), wavelet transform, and Hilbert-Huang transform were used. It was found that the Hilbert-Huang transform (HHT) had the advantage in dealing with non-stationary signals [18]. Yang et al. also used HHT to study the AE signal caused by grinding burn. Furthermore, it gives good final results [19]. Rao-Blackwellized (RBPF) technique which is called statistical noise removal technique. RBPF was proved to work well in detection and diagnosis small changes. To improve the signal noise ratio (SNR) of AE signal, proposed the partial filter RBPF. In addition, the RBPF was suitable for enhancing the SNR of AE signals, when analysis of the AE data [20]. To denoising should be improved wavelet threshold, which may increase the SNR value of AE signal. The least squares support vector machine (LS SVM) method was used to understand working conditions of pipelines [21]. Liang and Zhang found a new detection of pipeline leakage, which involves the principal component analysis (PCA), wavelet packet analysis (WPA), Gaussian mixture model (GMM), and the Bayesian information criterion (BIC). It was effective in experiments [22]. Sun et al. suggested a small leak feature extraction and a recognition method depends on local mean decomposition (LMD) envelope spectrum entropy and support vector machine (SVM) [23]. Mao et al. found that the FFT analysis of AE signals, which is developed for monitoring laser welding processes. The experimental data are in good agreement with results [24]. Antonaci et al. found that the analysis of AE signals using FFT to test the frequency distribution through the micro-cracking process. The method for fatigue damage evolution with AE signal was proved to be effective [25].

### **V. The Application of AE Technique**

#### **5.1. General Use:**

Applications of Acoustic Emission technology can be found in:

- Pressure equipment: AE is used to monitor flaws, corrosion, and leakage in pressure vessels, tanks, piping systems, steam generators.
- Aircraft and aerospace: aerospace structures, wings, bulkhead, fuel tanks, rocket engine, real time monitoring.
- Petrochemical and chemical: storage tanks, reactor vessels, offshore and onshore platforms, drill pipe, pipeline.
- Marine: corrosion, composite shell, engine and power plant;
- Civil engineering: bridges, dams, cable suspension bridges, concrete structure reinforced by the composite.
- Research and development: acoustic emission is a useful technique to monitor and study the damage in materials and their mechanical properties (new materials, smart materials).
- Wind turbine: blades damage [26].

#### **5.2. The Condition Monitoring of Valves**

Recently, the AE technique plays an important role in the industrial world; it is possible to monitor operation condition of valves through the relation between the AE parameters and leakage rate. Furthermore, can be maintenance or replacement of the parts before to the loss of safety function of valve parts. Fundamentally, the condition monitoring is used for valves in nuclear plants.

Allen et al. used the advanced detection and monitoring for two mainly types of failure in the valve used in nuclear power plant[27]. Haynes et al. studied three diagnosis methods in check valve, which include acoustic emission with ultrasonic and magnetic flux. They found that the collection of acoustic emission with ultrasonic flux or magnetic flux was considerable in the detection of operation conditions in check valve[28]. Hukri et al. debated the performance of AE technique as a fault detection monitoring system on control valves depend on statistical analysis parameters. AE established of measurement systems and tested, which can be applied to distinguish the operating cases of control valves[29]. Leey et al. used to condition monitoring of check valves using the AE technique and neural network. In this study, the AE technique gives good results for detection of a failure in the valve at an early stage [30]. Lee et al. found that the correlations between AE-RMS and failure modes, for example, foreign object and disk wear of check valves. In this study, they applied to AE technique and artificial neural network on the valves, which can be evaluated of several types of failure modes [31][32]. Figure 4 below shows the schematic diagram for condition monitoring test of the valve.

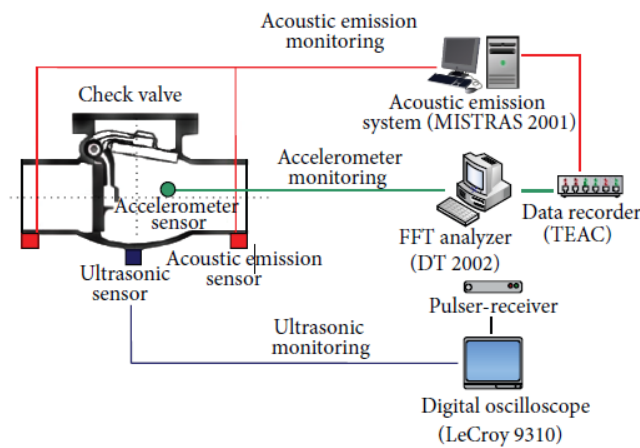

**Figure 4:** The Schematic Diagram for Condition Monitoring Test of the Check Valve [32].

## VI. Experimental Setup

There are many investigations conducted by researchers on the correlation between the AE signal and the leakage of the valve. Figure 5 shows the experiment system which consists of the AE system and leakage system. The ball valves and globe valves are chosen to be the test subjects due to their wide application. Experimentally, several sizes of valves have been tested so that a relationship between the valve size and the leakage rate can be established. The leakage is created by three methods: when the valve is partly opened[10], valve destructive partly[33], or source of leakage simulated [34]. The measurement system of AE consists of the AE sensor with a natural frequency of 150 kHz, the preamplifier, the band pass filter, amplifier, and the real-time signal analyzer. The AE sensor is used to get the AE signal [35]. Can be amplified the AE signals with amplifier 60 dB for their processing.

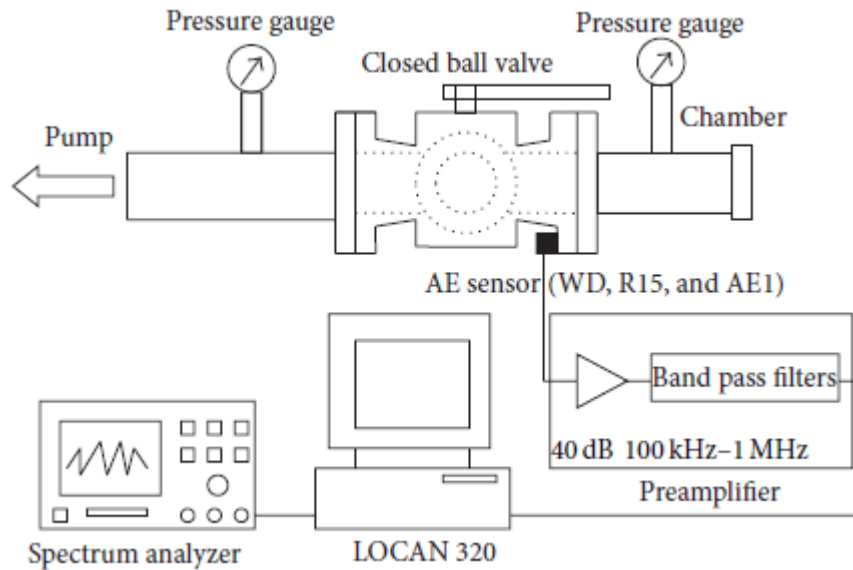

Figure 5: Diagram of Experimental Setup [4].

#### IV. Cavitation Phenomena

Bubble cavitation commonly occurs in fluid flows such as centrifugal pumps, valves and boiling processes. It is the localized formation and subsequent collapse of cavities or bubbles in a liquid. It also is a dynamic phenomenon that occurs in fluid flows when the local pressure is less than the saturated vapour pressure at ambient temperatures[36]. The cavitation is a big problem, causing severe damage in valves. The growth and collapse of bubble cavitation lead to the erosion or pitting of metal surfaces[4].

##### 7.1. Cavitation Occurrence in Valves

Figure 6 below shows cavitation occurrence in the globe valve. When the water travels upstream during valve throttling, it is subjected to minimum pressure and maximum velocity, which is called *Vena Contracta*. There are two possible scenarios at this region. The first, if the vena contracta pressure is greater than the vapour pressure, will result in no bubble formation (no cavitation). The second, if the vena contracta pressure is less than the vapour pressure, will cause bubble formation (cavitation). The pressure then recovers and increases above the vapour pressure, where the bubbles collapse into micro-jets. However, if the vena contracta pressure increases and remains less than the vapour pressure, flashing occurs[37].

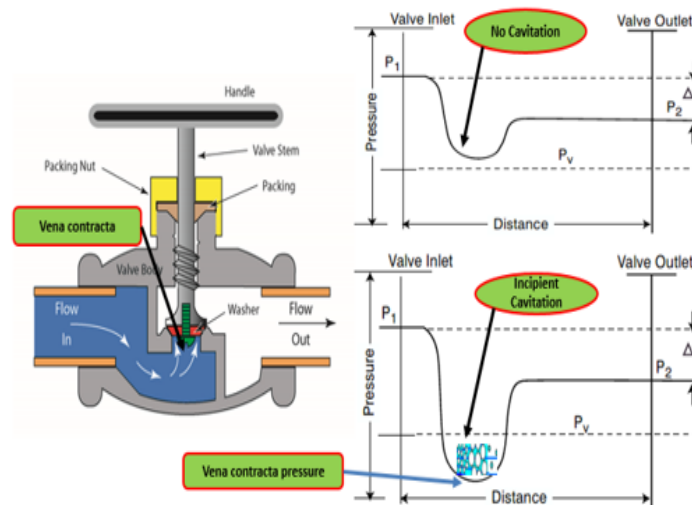
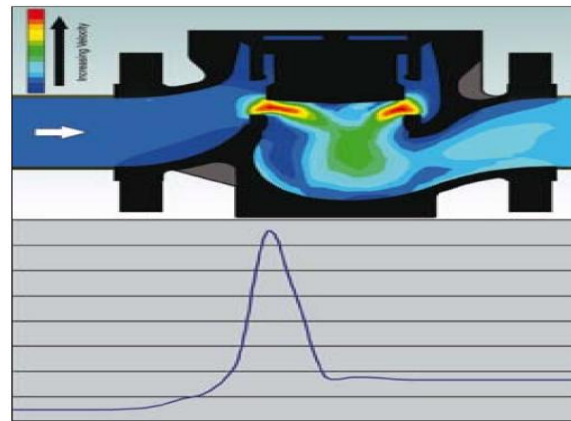

Figure 6: Pressure Distribution in Globe Valve

Leakage when the valve closed, if the liquid leakages, it moves from a high-pressure area to a low-pressure area that results in cavitation and potential damage [38].

### 7.2. Velocity Profile through Control Valves

The figure 7 below shows the velocity through a globe valve. When the liquid passes through a control valve, a 'vena contracta' (point of narrowest flow restriction), the velocity of fluid increases because the flow at this point is smaller than the rest of the flow path [39].



**Figure 7:** Velocity through a Control Valve [39].

### 7.3. Pressure Profile through Control Valves

The figure 8 below illustrates the pressure through a globe valve. "The increase in velocity at the vena contracta is caused by a transfer of pressure energy in the flow to velocity energy in the flow, resulting in lower pressure". While the fluid leaves this high-velocity area, the pressure gradually increases (pressure recovery).

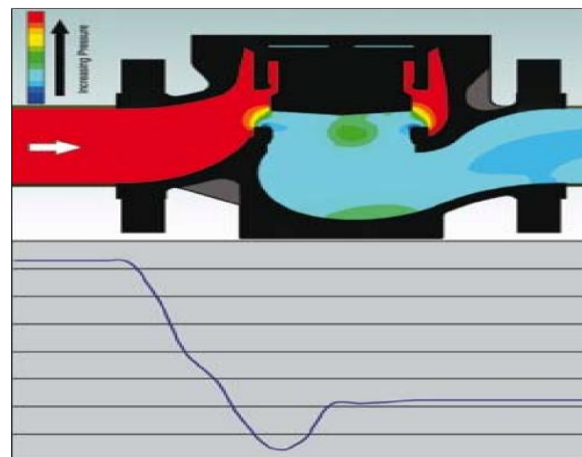

**Figure 8:** Pressure through a Control Valve [39].

### 7.4. Previous Studies:

Alfayez et al. found that the AE method is a useful technique for incipient detection of cavitation with the root-mean-square (RMS) value of the AE signal. Furthermore, there is a high possibility of determining the best efficiency point (BEP) of a centrifugal pump or system [40]. Taihret et al. [41] used the AE technique in the monitoring of bubble formation during the boiling process. They found that there is a clear association between increasing AE levels and the bubble formation during the boiling process. Masjedani Jazi et al. used two methods; characteristic diagrams and acoustic analysis in the detection of cavitation phenomena in globe valves. The two methods find similar results with acceptable levels of accuracy. Furthermore, they investigated acoustic waveform of cavitation in the globe valve and analysed the waveform and its important parameters using fast Fourier transform (FFT) [42].

In another investigation, Neill et al. monitored cavitation phenomenon of a centrifugal pump based on the AE method and got a more accurate result than that produced by the vibration signal [43]. Bo-Suk Yang et al. found that butterfly valves are usually used in industrial and waterworks pipeline systems with large diameter because they are lightweight and have a simple structure. Sometimes, when cavitation occurs in valves, it causes noise, vibration and rapid deterioration of the valve. They suggest statistical feature evaluation and support

vector machines (SVM) to detect incipient cavitation in butterfly valves that are used as a flow control valve at the pumping station. They compare this method with the self-organizing feature map (SOFM) method and found that the classification accuracy of SVMs was better than that of SOFM [44]. Husin et al. used AE method to detect bubble formation and burst. All studies have proved the possibility of monitoring and detecting of bubble condition and obtaining flow patterns during the liquid flow phase by using the AE system[45]. Salem A. Alhashmi et al. found that the cavitation is a common fault in centrifugal pumps where it causes failure and damage in pumps components. Furthermore, it produces high vibration and noise. To avoid cavitation and maintain centrifugal pump performance, it is necessary to use the excellent system for detection and diagnosis of cavitation where used to different methods for monitoring cavitation. These methods include vibration, acoustic, instantaneous angular speed and motor current signature. Analysing and comparing the capability of each method was necessary for defining the optimal method for detection of cavitation in the centrifugal pump. The pumping system was customised in other to monitor the occurrence and nature of cavitation within it efficiently. Signal data was processed and analysed using Mat lab software. Moreover, he added some important new contribution to the field of condition monitoring of cavitation in the centrifugal pumps. These contributions contain detection and diagnosis cavitation in the centrifugal pump by using instantaneous angular speed. Moreover, these contributions take account of utilising low frequency (0-1Kz) of vibration for monitoring of cavitation in centrifugal pump [46].Mohammed Abbas et al. used to the numerical simulation (ANSYS CFX software Release 12) to detect the cavitation in the centrifugal pump. The total pressure flow boundary is reduced in small increment to meet the start cavitation. ANSYS CFX software calculates the CFD (Computational Fluid Dynamic). It can showthat the formation bubble form in a less pressure region which caused by high-velocity water. Inception cavitation happens on the blade surface where the leading edge meets the tip. For lower net positive suction head (NPSH) values, the cavitation areas travel from leading to trailing edge. The drop in the NPSH curve began when the cavity length reached the maximum chord length of the blade. The start of cavitation in the blade passage can be detected and publicised in quality and quantity with numerical simulation. The cavitation is taking place on the suction surface where the leading edges meet the tip. In pressure, distribution plot demonstrations that the cavitation area is expanding to the trailing edge especially in high cavitation case. The net positive suction head available (NPSHA) of the system should be equal to or more than the net positive suction head required (NPSHR)of the centrifugal pump to avoid cavitation difficulties [47].Derakshan et al. monitored cavitation of hydraulic turbines through the measurement and analysis of the true RMS of AE signals [48]. Kim et al. found that the inception of cavitation causes head and efficiency of the primary pump to reduced significantly and generates vibration and noise. To avoid this phenomenon, the inlet of the pump fitted with a singlerotor called an inducer, which can operate satisfactorily with general cavitation. The enthusiasm of this study is to find out cavitation modes from the inducer upstream pressure signals and event characteristics from downstream ones at different operating conditions. The cavitation modes analysed by using a cross-spectral density of fluctuating pressures at the inducer inlet. Permanently exposing on cavitation for quite a period makes pump impeller and casing damaged. Most of the inducer designed at a maximum efficiency point of the pump, therefore, the decrease of suction performance, due to the effects of flow separation, and inverse inlet flow at off-design points is often observed [49].Tan Lei et al. simulated cavitation flow in centrifugal pumps at a low flow rate. They found good results by calculating the values of net positive suction head available when compared with experimental work. Cavitation is an unacceptable phenomenon caused by pressure drop. It reduces the efficiency and life of the pump. Also, the micro-jets due to bubbles collapse cause impeller damage, vibration, and noise[50]. Stopa et al. present a computer-based tool to help in the process of finding cavitation phenomenon in centrifugal pumps. The toolis called load torque signature analysis (LTSA), and it uses electrical signals from the motor to determine the torque developed by the pump, and via its frequency spectrum material defines the occurrence and intensity of the phenomenon. They also found that the results are very close to those obtained by the vibration method [51]. The method of detecting the cavitation in valves using the noise has not high precision because of the influence of background noise. The AE technique is a usefulmethodfor detection and monitoring of cavitation phenomena in valves.

## **VII. Conclusions**

Bubble cavitation and leakage are unacceptable phenomena in expensive equipment such as valves because causes of failure in hydraulic systems. Failure modes of valves normally occur as a result of pitting due to undetected cavitation conditions. Thus, the early detection failures of such vital components are important. Successfully implementing a condition monitoring programme that can pick up early signs of bubble formation leads the pumps and valves to operate at their full capacity without having to stop the machine for frequent inspections. To date, most published works showed that there had been few attempts of the application of the AE technique for the monitoring and detection of cavitation phenomena in valves. When a valve moves its operation point towards a cavitation condition, the cavitation process is initiated by an early phase during which

there is some formation of bubbles leading to what is called cavitation onset or flashing. However these bubbles do not, in this particular condition, go to collapse in an explosive manner.

The principle of AE was shown, and the public parameters analysis methods were researched in this paper. The Parameter of AE-RMS is proved to have a strong relationship with the fluid parameters and the valve parameters, such as the valve types and valve size, the leakage rate, the inlet pressure, and the types of fluid viscosity. The applications of new processing methods of AE signals including fast Fourier transform (FFT), wavelet transform, Hilbert-Huang transform (HHT), neural networks, and genetic algorithm in valves are presented. All results have shown that the AE technique can work well in the field of valves.

## References

- [1]. E. Meland, V. Henriksen, E. Hennie and MR. Spectral analysis of internally leaking shut-down valves. *Measurement*. 2011; vol. 44: pp. 1059–1072.
- [2]. J. M. Rajtar and R. Muthiah. Pipeline leak detection system for oil and gas flowlines. *Journal of Manufacturing Science and Engineering*. 1997; vol. 119,: pp. 105–109.
- [3]. F. Han, B. Song, T. Yu and WC. Present state and prospects for valve reliability technique study. *Machine Tool & Hydraulics*. vol. 9: p. 48.
- [4]. Yan J, Heng-hu Y, Hong Y, Feng Z, Zhen L, Ping W, et al. Nondestructive Detection of Valves Using Acoustic Emission Technique. 2015; 2015. Available at: DOI:10.1155/2015/749371
- [5]. G. Thompson and G. Zolkiewski. An experimental investigation into the detection of internal leakage of gases through valves by vibration analysis. *Proceedings of the Institution of Mechanical Engineers*. 1997; vol. 211, .
- [6]. P. Nivesrangsan, J. A. Steel and RLR. Acoustic emission mapping of diesel engines for spatially located time series—part II: spatial reconstitution. *Mechanical Systems and Signal Processing*. 2007; vol. 21: pp. 1084–1102.
- [7]. K. A. El-Shorbagy. An investigation into noise radiation from flow control valves with particular reference to flow rate measurement. *Applied Acoustics*. 1983; vol. 16: pp. 169–181.
- [8]. M. A. Sharif and R. I. Grosvenor. Internal valve leakage detection using an acoustic emission measurement system. *Transactions of the Institute of Measurement and Control*.. 1998; vol. 20: pp. 233–242.
- [9]. S.-G. Lee, J.-H. Park, K.-B. Yoo, S.-K. Lee and S.-YH. Evaluation of internal leak in valve using acoustic emission method,. *Key Engineering Materials*. 2006; vol. 326–3: pp. 661–664.
- [10]. W. Kaewwaewnoi, A. Prateepasen and PK. Investigation of the relationship between internal fluid leakage through a valve and the acoustic emission generated from the leakage. *Measurement*. 2010; vol. 43: pp. 274–282.
- [11]. Alssayh MAA. Slug Velocity Measurement and Flow Regime Recognition Using Acoustic Emission Technology. Cranfield University; 2013.
- [12]. NDT NT. AE Signal Features. 2015. Available at: [https://www.nde-ed.org/EducationResources/CommunityCollege/OtherMethods/AE/AE\\_Signal\\_Features.htm](https://www.nde-ed.org/EducationResources/CommunityCollege/OtherMethods/AE/AE_Signal_Features.htm) (Accessed: 1 August 2015)
- [13]. W. Kaewwaewnoi, A. Prateepasen and PK. Measurement of valve leakage rate using acoustic emission. *Proceedings of the International Conference on Electrical Engineering/Electronics, Computer, Telecommunications, and Information Technology (ECTI '05)*. 2005; : pp. 597–60.
- [14]. P.Chen, P. S. K. Chua andG. HL. Astudy of hydraulic seal integrity,” *Mechanical Systems and Signal Processing*. *Engineering Materials*. 2007; vol. 21: pp. 115–1126.
- [15]. A. Prateepasen, W. Kaewwaewnoi and PK. Smart portable noninvasive instrument for detection of internal air leakage of a valve using acoustic emission signals. *Measurement*. 2011; vol. 44: pp. 378–384.
- [16]. Q.-X. Gao, L.-P. Li, H.-D. Rao, J. Yang and Y-JZ. Acoustic emission theory and testing technology for quantitative diagnosis of valve leakages. *Journal of Chinese Society of Power Engineering*. vol. 32: pp. 42–46.
- [17]. X. Li. A brief review: acoustic emission method for tool wear monitoring during turning. *International Journal of Machine Tools and Manufacture*. 2002; vol. 42: pp. 157–165.
- [18]. C. Lu, P. Ding and ZC. Time-frequency analysis of acoustic emission signals generated by tension damage in CFRP. *Procedia Engineering*. 2011; vol. 23: pp. 210–215.
- [19]. Z. Yang, Z. Yu, C. Xie and YH. Application of Hilbert–Huang Transform to acoustic emission signal for burn feature extraction in surface grinding process. *Measurement*. 2014; vol. 47: pp. 14–21.
- [20]. A. Albarbar, F.Gu, A.D. Ball and AS. Acousticmonitoring of engine fuel injection based on adaptive filtering techniques. *Applied Acoustics*. 2010; vol. 71: pp. 1132–1141.
- [21]. H. Jin, L. Zhang, W. Liang and QD. Integrated leakage detection and localization model for gas pipelines based on the acoustic wave method. *Journal of Loss Prevention in the Process Industries*. 2014; vol. 27: pp. 74–88.
- [22]. Zhang WL and L. Awave change analysis (WCA) method for pipeline leak detection using Gaussian mixture model. *Journal of Loss Prevention in the Process Industries*. 2012; vol. 25: pp. 60–69.
- [23]. J. Sun, Q. Xiao, J. Wen and FW. Natural gas pipeline small leakage feature extraction and recognition based on LMD envelope spectrum entropy and SVM. *Measurement*. 2014; vol. 55: pp. 434–443.
- [24]. Y. L. Mao, G. Kinsman and WWD. Real-time fast Fourier transform analysis of acoustic emission during CO2 laser welding of materials. *Journal of Laser Applications*. 1993; vol. 5: pp. 17–22.
- [25]. P. Antonaci, P. Bocca and DM. Fatigue crack propagation monitoring by Acoustic Emission signal analysis. *Engineering Fracture Mechanics*. 2012; vol. 81: pp. 26–32.
- [26]. Elforjani MA, Condition. Condition Monitoring of Slow Speed Rotating Machinery Using Acoustic Emission Technology SCHOOL. *Journal of Chemical Information and Modeling*. Cranfield Univesity; 2010. Available at: DOI:10.1017/CBO9781107415324.004
- [27]. J. W. Allen, W. F. Hartman and JCR. Acoustic monitoring of power-plant valves. *Technology for Energy*, Knoxville.
- [28]. Haynes HD. Evaluation of check valve monitoring methods. *Nuclear Engineering and Design*. 1992; 134: pp. 283–294.
- [29]. I. N. B. M. Shukri, G. Y. Mun and RBI. A study on control valve fault incipient detection monitoring system using acoustic emission technique. in *Proceedings of the 3rd International Conference on Computer Research and Development (ICCRD '11)*. 4: pp. 365–370.
- [30]. S. Lee Y, J. Jeon S and JL. Condition monitoring of check valve using neural network. in *Proceedings of the International Academic Conference*. : pp. 2198–2202.



- [31]. J.-H. Lee, M.-R. Lee, J.-T. Kim and J.-S.K. Analysis of acoustic emission signals for condition monitoring of check valve at nuclear power plants. *Key Engineering Materials*. 2004; 270–273: pp. 531–536.
- [32]. J.-H. Lee, M.-R. Lee, J.-T. Kim, V. Luk and Y.-H.J. A study of the characteristics of the acoustic emission signals for condition monitoring of check valves in nuclear power plants. *Nuclear Engineering and Design*. 2006; 236, no. 1: pp. 1411–1421.
- [33]. M.-R. Lee, J.-H. Lee and J.-T.K. Condition monitoring of a nuclear power plant check valve based on acoustic emission and a neural network. *Journal of Pressure Vessel Technology*. 2005; 127(3): pp. 230–236.
- [34]. M. Noipitak, A. Prateepasen and W. K. A relative calibration method for a valve leakage rate measurement system. *Measurement*. 2011; 44(1): , pp. 211–218.
- [35]. T. Yan, P. Theobald and B.E.J. A self-calibrating piezoelectric transducer with integral sensor for in situ energy calibration of acoustic emission. *NDT & E International*. 2002; 35(7): pp. 459–464.
- [36]. W. Liang, L. Zhang, Q. Xu and C.Y. Gas pipeline leakage detection based on acoustic technology. *Engineering Failure Analysis*. 2013; vol. 31.
- [37]. Carlson B. Avoiding cavitation in control valves. *ASHRAE Journal*. 2001; 43(6): 3–6. Available at: [www.ashraejournal.org](http://www.ashraejournal.org) (Accessed: 15 May 2015)
- [38]. EMERSON. Cavitation demo. Published on May 2, 2012, Standard YouTube License; 2012. Available at: [https://www.youtube.com/watch?v=ZlrFMmGs\\_NI](https://www.youtube.com/watch?v=ZlrFMmGs_NI)
- [39]. Flowserve. Flowserve Cavitation Control. 2006; : 1–20. Available at: [www.flowserve.com](http://www.flowserve.com) (Accessed: 5 May 2015)
- [40]. 24. Alfayez, L., D. Mba and G. dyson. Detection of incipient cavitation and the best efficiency point of 2.2MW centrifugal pump using acoustic emission. in 26th Eu. Berlin; 2004.
- [41]. Alhashan T, Elforjani M, Addali A, Teixeira J. Monitoring of Bubble Formation during the Boiling Process Using Acoustic Emission Signals. *International Journal of Engineering Research & Science (IJOER)*. 2016; 2(4): 66–72.
- [42]. Masjedian Jazi a., Rahimzadeh H. Detecting cavitation in globe valves by two methods: Characteristic diagrams and acoustic analysis. *Applied Acoustics*. Elsevier Ltd; 2009; 70(11-12): 1440–1445. Available at: DOI:10.1016/j.apacoust.2009.04.010
- [43]. Neill, G.D., Reuben, R.L. and Sandford PM. Detection of Incipient Cavitation in Pumps using Acoustic Emission. *Journal of Process Mechanical Engineering, IMechE*. 1997; 211(4): 267–277.
- [44]. Yang BS, Hwang WW, Ko MH, Lee SJ. Cavitation detection of butterfly valve using support vector machines. *Journal of Sound and Vibration*. 2005; 287(1-2): 25–43. Available at: DOI:10.1016/j.jsv.2004.10.033
- [45]. Husin S, Addali A, Mba D. Feasibility study on the use of the Acoustic Emission technology for monitoring flow patterns in two phase flow. *Flow Measurement and Instrumentation*. Elsevier; 2013; 33: 251–256. Available at: DOI:10.1016/j.flowmeasinst.2013.07.011
- [46]. Alhashmi SA. Detection and diagnosis of cavitation in centrifugal pumps. PhD thesis. University of Manchester; 2005.
- [47]. Abbas MK. Cavitation in centrifugal pumps. Engineerin. Diyala University.; 2010.
- [48]. Derakhshan JO, Houghton RR JK. Cavitation monitoring of hydro turbines with RMS acoustic emission measurements. *Proceedings of the world meeting on acoustic emission*. 1989; 15: p.305.
- [49]. Lee S, Jung K, Kim J, Kang S. Cavitation Mode Analysis of Pump Inducer. 2002; 16.
- [50]. T. Lei WY. Cavitation flow simulation for a centrifugal pump at low flow rate. 2013; (Tsinghua University).
- [51]. Hosien M a., Selim SM. RETRACTED ARTICLE: Experimental study of cavitation criterion in centrifugal pumps. *Journal of Visualization*. 2013; 16(2): 99–110. Available at: DOI:10.1007/s12650-012-0149-7.