

Development of Intelligent System for EEG Signal Analysis Using Artificial Neural Network

Prof. (Dr.) M.K. Bhaskar¹, Prof. Surendra. Bohra²

¹Professor, Electrical Engg. Department, M.B.M. Engg. College, Jodhpur, Raj, India

²Professor, ECE Department, SLBS Engg. College, Jodhpur, India

Abstract: *The Life of people is becoming complicated every day due to explosion of population leading to crises of land, employment, agricultural proceeds, price hikes etc. This is followed by crunch of resources on the one hand and drastic fall in per capita income of country man also educational improvement is followed by its fruitlessness except intellectual development, under this situation countryman is facing stress on mind. Also the insecurity of careers and mental tensions are growing exponentially in the life of people. This may take the youth either to the direction of becoming criminal or to direction of surrendering before the uncontrollable pressure of helplessness. Both the paths give rise to further insecurity and mental tensions. The ultimate part which is attacked is mental health of person due to overstressed conditions. It is therefore recovery of mental health has become an important challenging concern of the doctors. The human brain produces electrical signals which prove vital in understanding the degree of abnormality that may, in many cases, result in a person behaving unusually. The information contained in these signals is recorded via an EEG machine, which is able to extract even the most subtle details from the electrical waves that the brain signals generate usually, the signals from the aforementioned device are interpreted by the specialists who specialize in this very thing but heir defection is susceptible to errors which prove fatal in some cases. This research presents an autonomous system, capable of detecting the occurrence of an brain disorder, without the help of an expert.*

Keywords: EEG, ANN, EMG, BP, Electroencephalogram (EEG), SVM, Electroencephalogram Classification, Discrete Wavelet Transform (DWT)

I. Introduction

Electroencephalogram (EEG) is a complex human brain signal consisting of high information about brain function and neurological disorders. The aim of present work is to

- (I) Identify brain disorders (Knowledge base for disorders)
- (II) Diagnosis of brain disorders using ANN

The study therefore requires to be carried out in following steps.

- (i) To develop Knowledge base for brain disorders : This requires to obtain brain signals which are in the form of EEG / EEM to confirm the brain disorders of specific nature and,
- (ii) To develop diagnostic tools which provide the identification of brain disorder related to the pattern set of brain signals i.e. EEG/ EEM: This exercise will be centered on such diseases which will be common in large number of patients but are responsible for fatalities in human life.
- (iii) To develop ANN for diagnosis of brain disorders : This requires ANN to be formulated on Matlab and trained for brain signals relevant to specific brain disorders followed by its testing. The same shall be used as standard tool to provide for the brain disorder for the given pattern set of brain signals i.e. EEG/ EEM.
- (iv) To develop a simulink that provides for instrumentation for collection of brain signals from human brain from variety of patients. This would be followed by testing of the data on ANN for determination of brain disorder.

II. Study of ANNS

Artificial neural networks have different structures and every structure is suitable for specific application. It therefore requires selecting train and testing the ANN before it is used for diagnosis of brain disorders. The types of ANNs available are:

- (i) Feed forward Neural Network
- (ii) Error back Propagation Network
- (iii) Hopfield network
- (iv) Boltzmann machine

The general architecture of ANN is given in fig 1

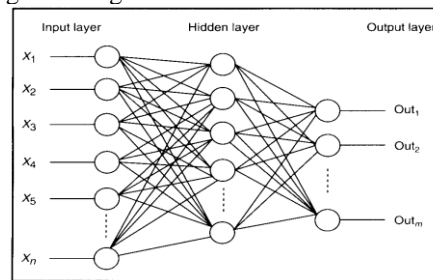

Fig. 1 Architecture of ANN

III. Testing and Diagnosis of Disorder on Human Scalp.

The developed instrumentation Hardware would be used to acquire Brain signal from real patients and the signal so received will be applied to the pattern classifier to locate the type of brain disorder. This would however require to visit the clinical zone.



Fig. 2 Use of Needle Electrodes



Fig. 3 Modern EEG Machine

These machines have a programmable montage selection for example upto eight electrode combinations can be selected with a keyboard switch. Any desired combination of electrodes can be selected with push buttons. The monitor screen display the selected pattern (montage) as well as the position of scalp sites with electrode to skin contact. Individual channel settings are displayed on the video monitor for immediate review. Therefore a setting can be changed by a simple push button operation while looking at the display. Now a days, modern EEG machines uses computer with a Pentium processor 512 MB RAM, 40 GB hard disk and cache memory. The system can store data unlimitedly. The EEG is displayed on 43 cm color monitor with a resolution of 1280 X 1024 pixels. The hard copy of the electroencephalogram can be obtained through printer.

IV. Artificial Neural Networks (ANNS)

Ann are a family of models inspired by biological neural networks the central nervous systems of animals, in particular the brain) and are used to estimate or approximate functions that can depend on a large number of inputs and are generally unknown. Artificial neural networks are generally presented as systems of interconnected "neurons" which exchange messages between each other. The connections have numeric weights that can be tuned based on experience, making neural nets adaptive to inputs and capable of learning.

Neural networks are similar to biological neural networks in the performing of functions collectively and in parallel by the units, rather than there being a clear delineation of subtasks to which individual units are assigned. The term "neural network" usually refers to models employed in statistics, cognitive psychology and artificial intelligence. Neural network models which command the central nervous system and the rest of the brain are part of theoretical neuroscience and computational neuroscience

The word *network* in the term 'artificial neural network' refers to the inter-connections between the neurons in the different layers of each system. An example system has three layers. The first layer has input neurons which send data via synapses to the second layer of neurons, and then via more synapses to the third layer of output neurons. More complex systems will have more layers of neurons, some having increased layers of input neurons and output neurons. The synapses store parameters called "weights" that manipulate the data in the calculations.

V. Error Back Propagation Algorithm

Back propagation, an abbreviation for "backward propagation of errors", is a common method of training artificial neural networks used in conjunction with an optimization method such as gradient descent. The method corresponding to epileptic seizure from the mixture of EEG signals. This is followed by the training of the ascertained independent subcomponents, applying ANN (Artificial Neural Networks). Fig. 1 depicts the block diagram of epileptic seizure detection process from EEG signal using FastICA and Back Propagation Neural Network (BPNN). The methods calculates the gradient of a loss function with respect to all the weights in the network. The gradient is fed to the optimization method which in turn uses it to update the weights, in an attempt to minimize the loss function.

Backpropagation requires a known, desired output for each input value in order to calculate the loss function gradient. It is therefore usually considered to be a supervised learning method, although it is also used in some unsupervised networks such as autoencoders. It is a generalization of the delta rule to multi-layered feedforward networks, made possible by using the chain rule to iteratively compute gradients for each layer. Backpropagation requires that the activation function used by the artificial neurons (or "nodes") be differentiable.

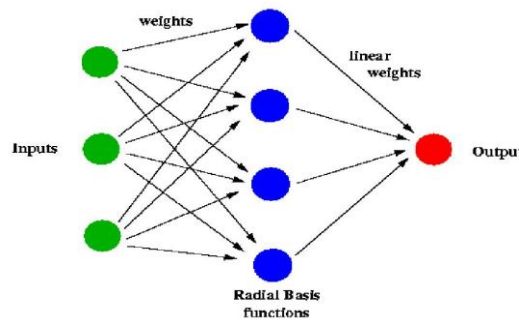

Fig. 4 Radial basis function

Radial basis networks consist of two layers: a hidden radial basis layer of S^1 neurons, and an output linear layer of S^2 neurons.

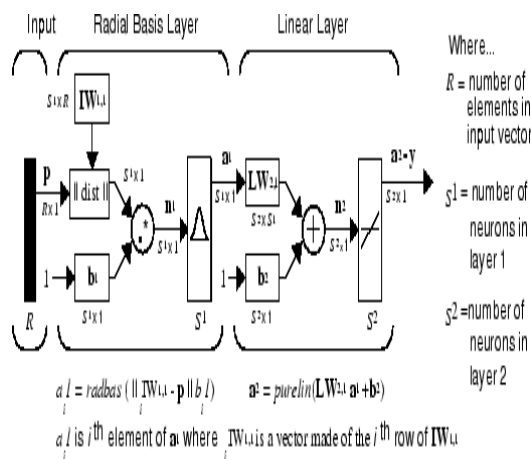

Fig. 5 Network architecture

The EEG Database

We have obtained EEG signals of various Brain disorders from Children Hospital Pitsburg Russia site and have processed them to maintain uniformity of presentation and for signal analysis. The EEG waveforms of various brain disorders is given as below.

1. Normal

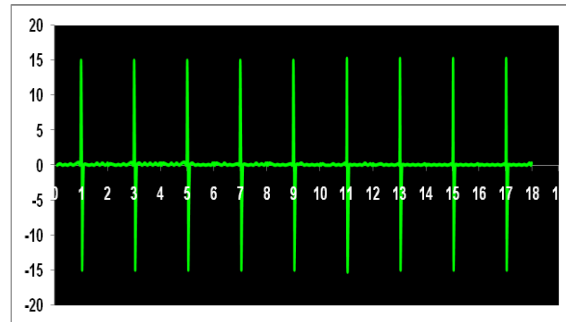

Fig. 6 EEG waveform of normal person

2. Benign Occipital

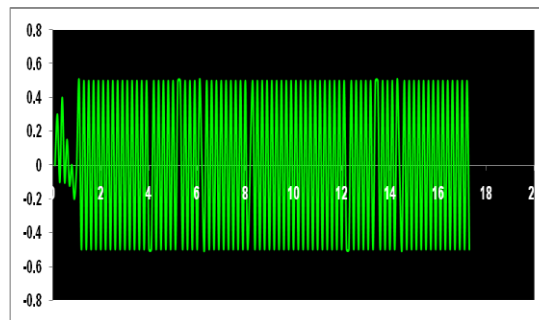

Fig. 7 EEG waveform of person suffering from benign occipital disorder

3. Benign R

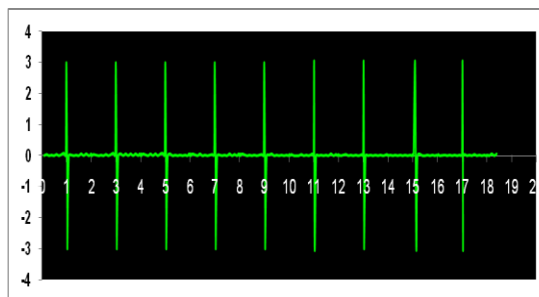

Fig. 8 EEG waveform of person suffering from Benign R disorder

4. Elzimer

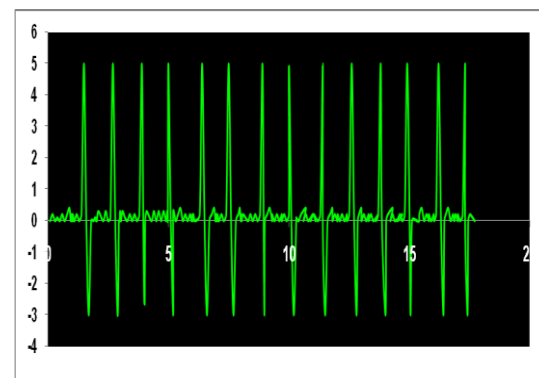

Fig. 9 EEG waveform of person suffering from Elzimer disorder

5. CJD

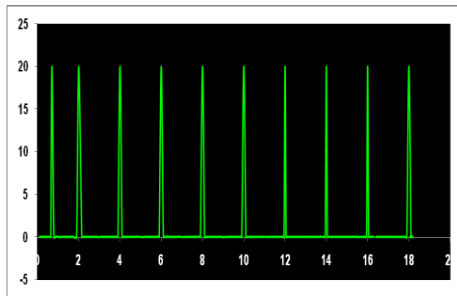

Fig. 10 EEG waveform of person suffering from CJD

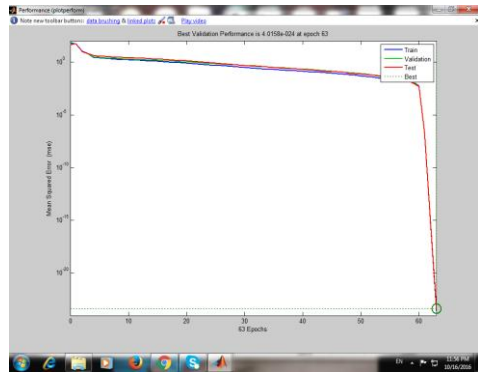

Fig. 11 Training results

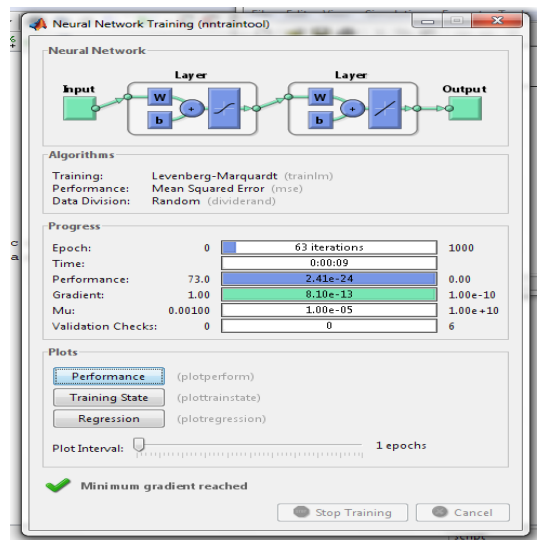

Fig. 12 RMS based ANN training

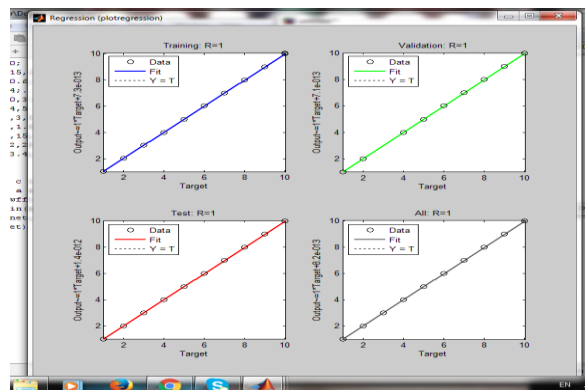

Fig. 13 RMS based regression plots

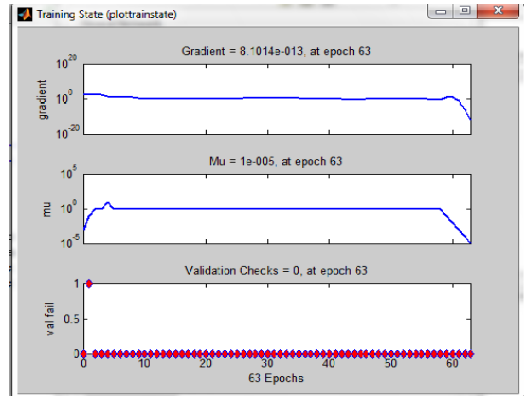

Fig. 14 RMS based training performance

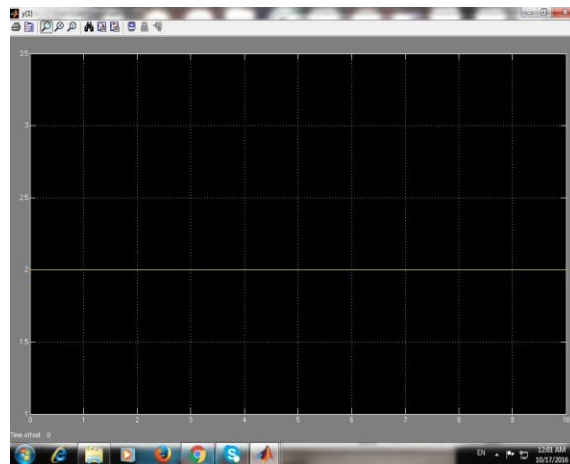

Fig. 4.15 Simulation outputs for benign occipital disorder

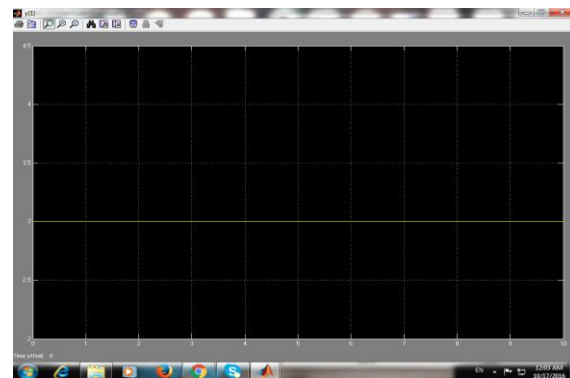

Fig. 4.16 Simulation outputs for benign R disorder

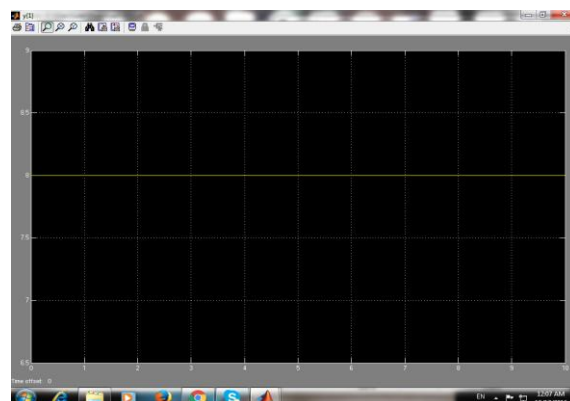

Fig. 4.18 Simulation outputs for dementia disorder

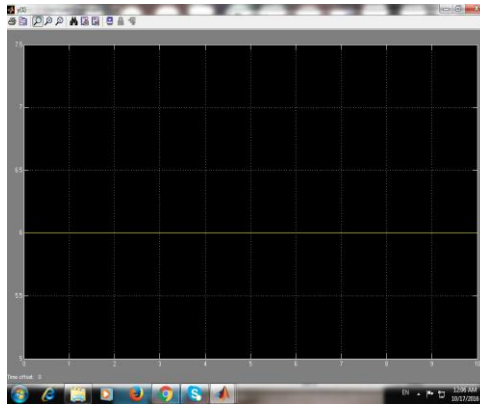

Fig. 4.19 Simulation outputs for elzimer disorder

VI. Conclusion

The basic signal which is used for identification of disease is same for R.M.S. approach and feature vector based approach. It is therefore the out comes of two approaches for recognition of the disease indicate same disease. The Mathematical analysis is corroborated by the ANN for the two approaches. Thus the diseases are recognized through intelligent system using artificial newural networks be cause the disease signals are fixed. This is also because the wrights of synapses in ANN become frozen after the completion of training. We Successfully trained the ANN with EBPN to efficiently classify the patterns of EEG Waveforms to respective Brain disorders. Thus we give an intelligent system which helps to classify the EEG record of patients using Soft computing approach.

References

- [1]. **M. Kalaivani, V. Kalaivani and V. Anusuya Devi** "Analysis of EEG Signal for the Detection of Brain Abnormalities" International Journal of Computer Applications (IJCA) ISSN: (0975-8887) International Conference on Simulations in Computing Nexus, ICSCN-2014, PP-1 to 6.
- [2]. **Sasikumar Gurumurthy, Vudi Sai Mahit and Rittwika Ghosh** "Analysis and simulation of brain signal data by EEG signal processing technique using MATLAB" International Journal of Engineering and Technology (IJET) ISSN : 0975-4024, Vol 5, No 3, Jun-Jul 2013, PP- 2771 to 2776.
- [3]. **Krishnaveni Yendrapalli, S. S. Naga Pavan Kumar Tammana** "The Brain Signal Detection for Controlling the Robot" International Journal of Scientific Engineering and Technology (IJSET) ISSN : 2277-1581, Volume No.3, Issue No.10, Oct-2014, pp : 1280-1283.
- [4]. **Abdul Kadar Muhammad Masum, Md. Faisal Faruque, Mohammad Shahjalal and Md. Iqbal Hasan Sarker** "Solving the Vehicle Routing Problem using Genetic Algorithm" International Journal of Advanced Computer Science and Applications(IJACSA), Vol. 2, No. 7, 2011, PP 126 to 131.
- [5]. **Om Prakash Verma and Himanshu Gupta** "Fuzzy Logic Based Water Bath Temperature Control System" International Journal of Advanced Research in Computer Science and Software Engineering (IJARCSSE), ISSN: 2277 128X, Volume 2, Issue 4, April 2012, PP 333 to 336.
- [6]. **P.D. Khandait, Dr. N.G. Bawane, Dr. S.S. Limaye and S.P. Khandait** "Efficient ECG Abnormalities Recognition Using Neuro-Fuzzy Approach" International Journal of Advanced Research in Computer Science and Software Engineering (IJARCSSE), ISSN: 2277 128X, Volume 2, Issue 4, April 2012, PP 402 to 407.
- [7]. **Richa Garg and Saurabh Mittal** "Optimization by Genetic Algorithm" International Journal of Advanced Research in Computer Science and Software Engineering (IJARCSSE) ISSN: 2277 128X, Volume 4, Issue 4, April 2014 PP 587 to 589.
- [8]. **Behrouz Minaei-Bidgoli and William F. Punch** "Using Genetic Algorithms for Data Mining Optimization in an Educational Web-based System" Genetic Algorithms Research and Applications Group (GARAGE).
- [9]. **Prof. Deepa. T. P., Prof. Vandana Reddy** "EEG Based Drowsiness Detection Using Mobile Device for Intelligent Vehicular System" International Journal of Engineering Trends and Technology (IJETT), ISSN: 2231-5381 Volume 6 Number 1- Dec 2013 PP- 21 to 24.
- [10]. **Mahalingam D, Rajkumar P, Banu Priya R and Sudha P** "Real Time Monitoring For Drowsiness Detection Using EEG System" SSRG International Journal of Electronics and Communication Engineering (SSRG-IJECE), ISSN: 2348 – 8549, Volume 2 Issue 5 – May 2015, PP- 78 to 80.