

## **Modeling and Analysis of STATCOM by Using Modular Multilevel Converter**

S.Ghouse Basha<sup>1</sup>, Y.Nagaraja<sup>2</sup>, B.N.Prasad<sup>3</sup>

<sup>1</sup>(Department of EEE, AITS,Kadapa, India)

<sup>2</sup>(Department of EEE, AITS,Kadapa, India)

<sup>3</sup>(Department of EEE, AITS,Kadapa, India)

---

**Abstract:** A new high-power STATCOM based on a modular multilevel converter (MMC) which is used to compensate an unbalanced and distorted medium-voltage load is proposed in this paper. The main goal of MMC based STATCOM is capable of reactive power compensation, harmonic cancellation, and simultaneous load balancing, while controlling and balancing all of the DC mean voltages even during the transient states. These are controlled by using a phase-shifted carrier modulation strategy for fast compensation of the reactive power and harmonics, and also for the balancing of the three-phase source side currents. Simulation results are obtained by proposed MMC based STATCOM for unbalance load and for different fault conditions.

**Keywords:** Modular multilevel converter (MMC), STATCOM, phase-shifted carrier modulation strategy, unbalance currents.

---

### **I. Introduction**

From the electric energy conversion point of view we have four basic converter types[2] those are as follows, Rectifiers convert an input AC voltage and current to an DC output voltage and current, choppers convert an input DC voltage and current to an output DC voltage and current of different values, inverters convert an input DC voltage and current to an output AC voltage, current, frequency and count of phases, AC converters convert an input voltage, current, count of phases and frequency to an AC energy with different parameters. The frequency converters that convert an input frequency to an output frequency and that simultaneously maintain the count of phases create a subgroup of AC converters and they are the most widespread converters in the field of electrical drives. Voltage source converters can be classified into three types as follows [3]

- Two level converter
- Three level converter
- Modular Multilevel Converter (MMC)

Modular Multilevel Converter (MMC) starts at the year 2003, A. Lesnicar and R.Marquardt first described the new topology in their article [1]. First commercial use of MMC is Trans Bay Cable project in San Francisco, USA [4].The design of MMC was provoked by the development of power generation, which required converters with multiple voltage levels.

### **II. MMC Based STATCOM**

Now a day, multilevel converters are used like the power stages in STATCOM's [24], [25].due to their advantages over other converter topologies. The voltage stresses can be reduced when the number of levels increases the power switches are driven with a low communication frequency and multilevel converters can synthesis a voltage waveform with a very low harmonic content [26]-[31].when compared with diode clamped multilevel converters ,the cascaded multilevel converters can be directly connected to a medium-voltage network without a bulky step up transformer which results to cost and weight reductions [29]-[32].In this paper we realize a transformer less STATCOM based on a MMC is as shown in figure 1. Such a feature was already known from the Cascaded H-Bridge (CHB) converter of [5]. For the compensation of a non linear unbalanced load in a medium voltage level. For this purpose a control strategy based on the instantaneous power theory is developed for extracting the compensating current signals.

Modular multilevel converters [33] have recently proposed as an alternative to conventional multilevel converters in medium voltage applications [34]-[35]. The basic structure of a four wire STATCOM based on MMC is as shown in fig 1.MMC consists of two polarized star connected half bridge cascaded converters (HBCC) which are connected in parallel to the network i.e., one HBCC with –ve common link(NL-HBCC) and

other with the +ve common link (PL-HBCC) and negative ,positive links are floating points. Each leg of HBCC consists of series connected half bridge modules (HBM) as shown in the fig 1.

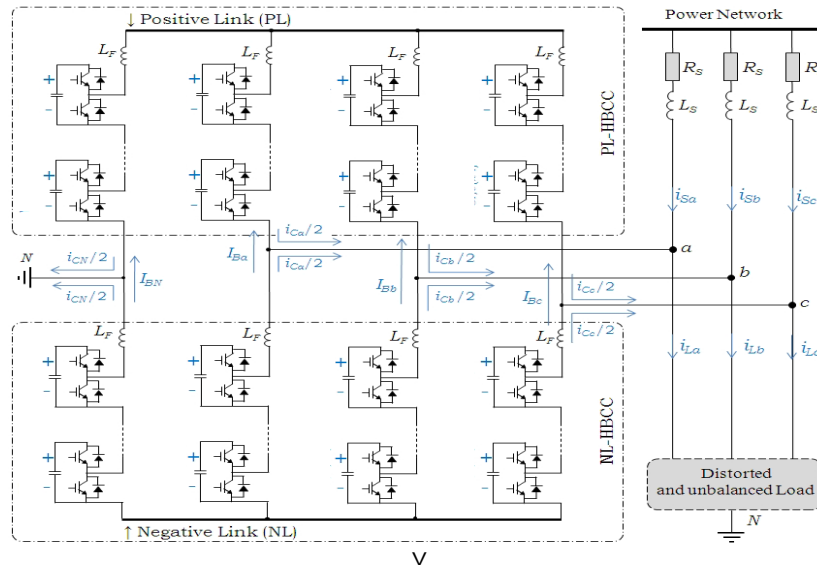

Fig.1: Schematic diagram of MMC-based STATCOM.

### III. Voltage Balancing Strategies

Despite of many advantages of modular multilevel converters such as lower harmonic content, modularity and fault tolerant operation there are many technical challenges associated with it. One of the main challenges associated with the control of MMC is to balance the sub module capacitor voltage levels [6]. As a result of capacitor voltage variation the voltages in the three phase units differ. The difference in the voltage may lead to circulating currents and consequently it increases converter losses [7].

There are several modulation strategies to control the multi level converters. The most commonly used is the multi carrier PWM technique [8]. The advantage of multi carrier PWM strategies is that it can be easily implemented to low voltage modules. Multi carrier PWM strategies are classified into two types they are as follows:

1. Level shifted PWM
  - Phase Disposition (PD) PWM
  - Phase Opposition Disposition (Pod) PWM
  - Alternative Phase Opposition Disposition (APOD) PWM
2. Phase Shifted (PS) PWM

Level shifted PWM are the carrier signals are displaced within the levels. This approach provides unequal duty cycles and power distribution. With this technique capacitor voltage balancing cannot be achieved. Phase shifted PWM are the carrier signals have phase shifts among them. This approach ensures equal duty cycles and power distribution. Capacitor voltage balancing can be achieved with proper selection of the carrier frequency.

The phase-shifted carrier (PSC) PWM modulation is an attractive to MMC as it has some distinctive features:

- 1) The semiconductor stress and the power handled by each SM are evenly distributed. Hence, the capacitor voltage balancing control can be easily achieved.
- 2) The output voltage has a high resulting switching frequency and a low total harmonic distortion (THD).
- 3) Consistent with the structure of MMC, each triangular carrier associated to a particular SM presents the nature of modularity and scalability.

#### Phase Shift PWM (PSPWM):

- The phase shift multicarrier PWM technique has its performance parameters closest to PDPWM strategy [21]-[24]
- All the carriers have same amplitude and frequency but the carriers are displaced by shifting their phase.
- The phase shift can be done by choosing any delay but to achieve minimum harmonic distortion the delay is given by equation 1, where  $T_s$  is the switching period and N indicates number of levels.

$$\Delta = \frac{T_s}{N-1} \quad (1)$$

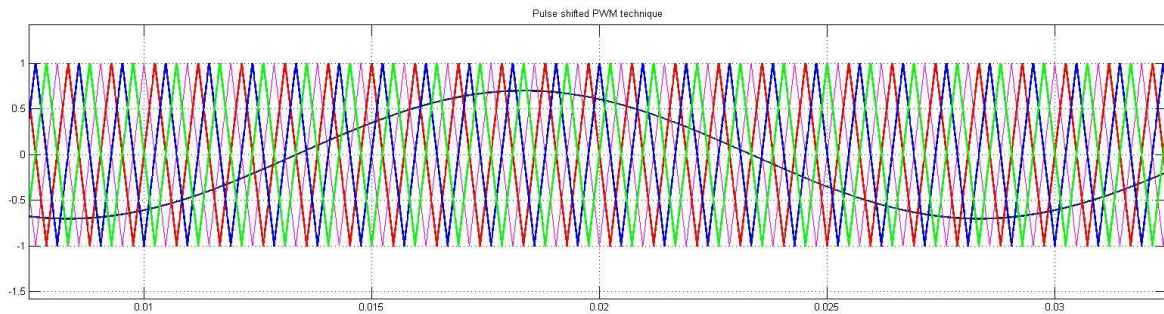

Fig.2: Pulse pattern for PSPWM

The capacitor voltage balancing and circulating current suppression are two major tasks associated with MMC and several control solutions based on feedback control or the sorting algorithm have been proposed and reported in [11]–[17]. In addition, as one of the most interesting topics, various pulse width modulation (PWM) techniques have been developed to fit MMC. The nearest level control (NLC), also known as the round method, was adopted in [9], [18], and [19]. This method is especially suitable for MMC with a large number of sub modules (SMs). Furthermore, [10] and [20] extend the application scope of NLC by introducing one SM working in PWM operation.

#### IV. Simulink Diagram

The simulink model of STATCOM by using Modular Multilevel Converter is as shown in the fig3.

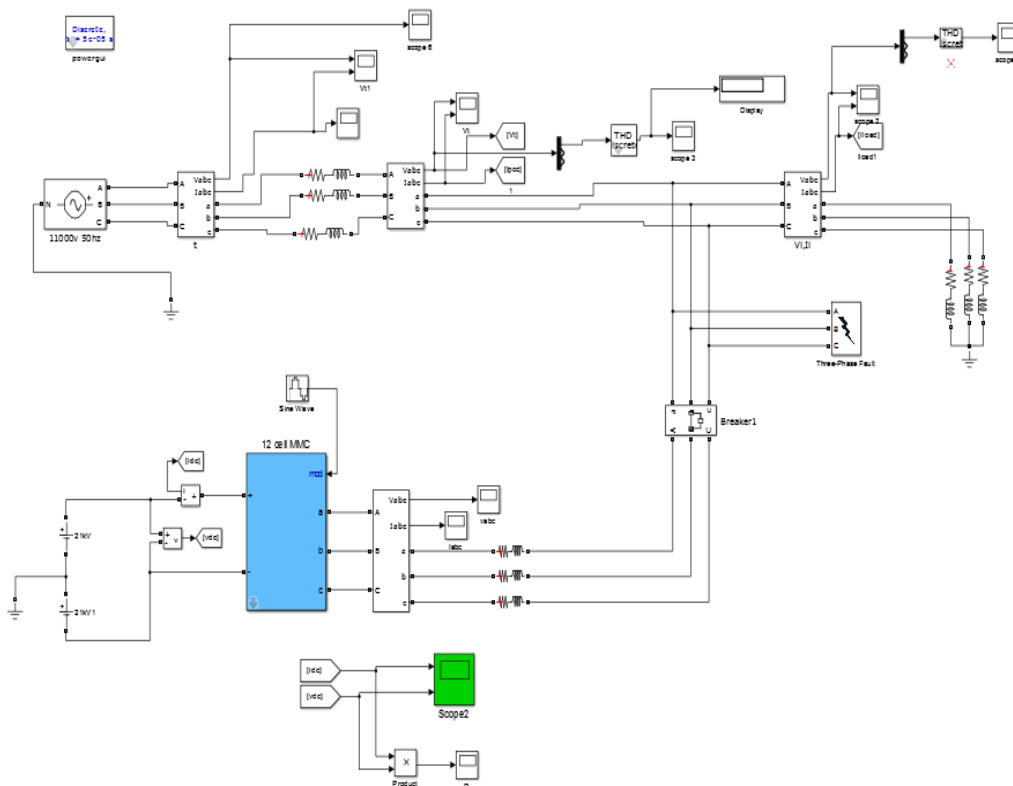

Fig.3. Simulation Diagram

### V. Simulation Results

The performances of MMC based STATCOM are evaluated by computer simulation using MATLAB/SIMULINK. The simulated system is shown in fig.3. This system was operated under the different conditions:

#### Case a: Performance of MMC based STATCOM in unbalance Mode

For the Modular Multilevel converter based STATCOM the respective output voltage and current is as shown in the below figure 4.

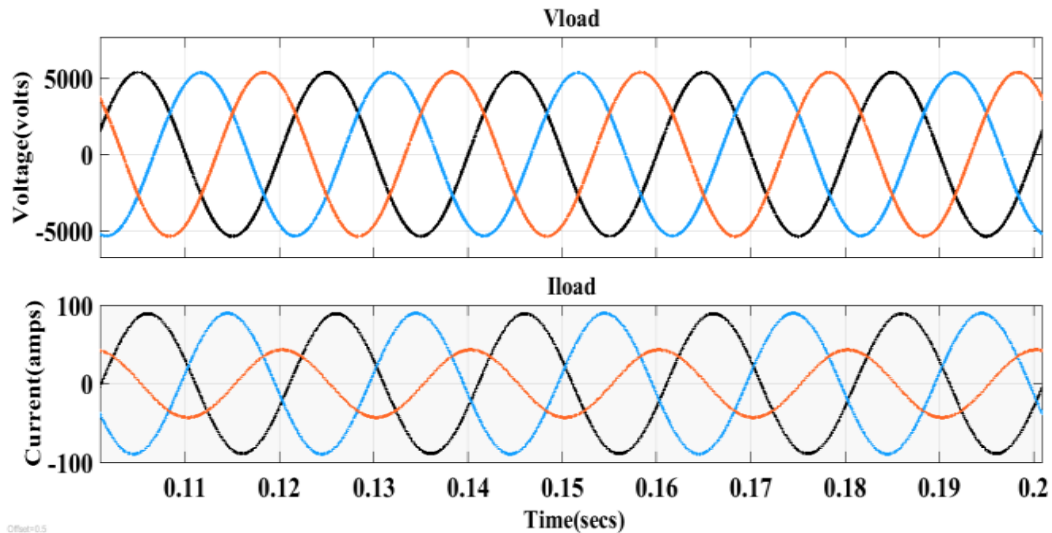

Fig.4. Modular Multilevel converter based STATCOM

From the above wave forms we clearly observed that a less number of distortions have happened in the load current due to the unbalanced load which results to the production of harmonics. The respective total harmonic distortion for Modular Multilevel converter based STATCOM is as shown below figure 5.

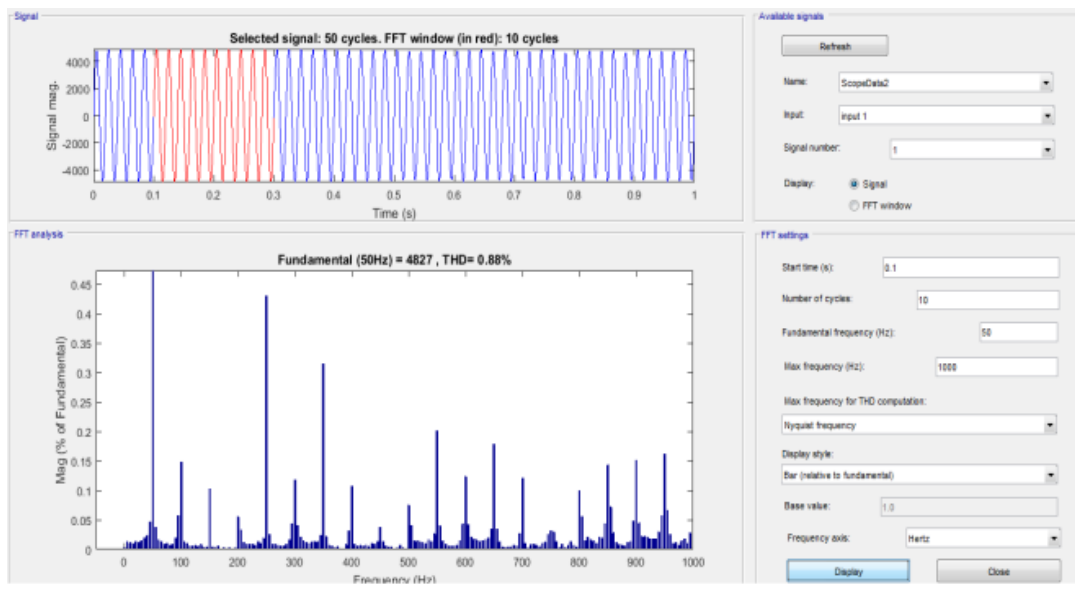
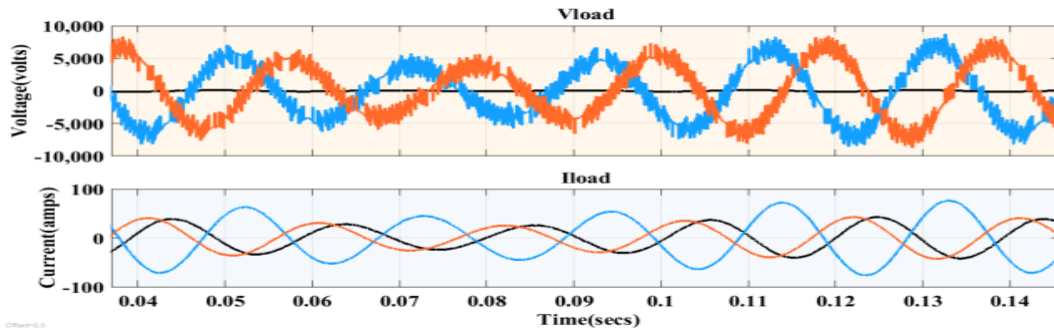

Fig.5. Total harmonic distortion of Modular Multilevel converter based STATCOM

The respective total harmonic distortion for Modular Multilevel converter based STATCOM is 0.88 % which is as shown above Fig.5.

**Case b: Performance of MMC Based STATCOM under Faulty Conditions  
LG FAULT:**



**Fig.6.** Modular Multilevel converter based STATCOM with LG fault

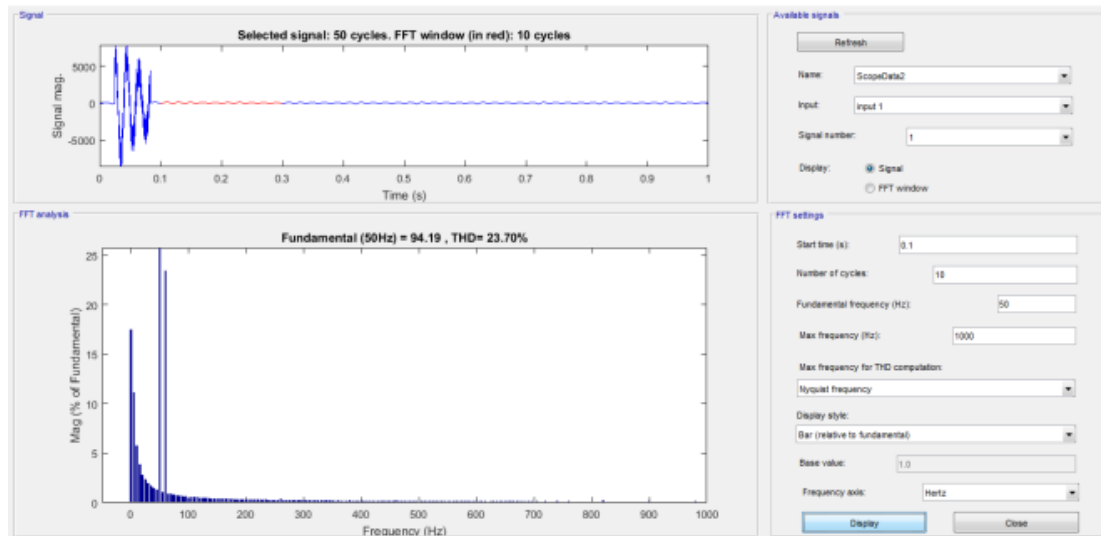

**Fig.7.** Total harmonic distortion of MMC based STATCOM with LG fault.

Modular Multilevel converter based STATCOM with LG fault is as shown in the above figure 6 & 7 as due to the LG fault the output has only two phases and the third phase is passing through the origin and the respective total harmonic distortion of LG fault is 23.70%.

**Double LG Fault :**

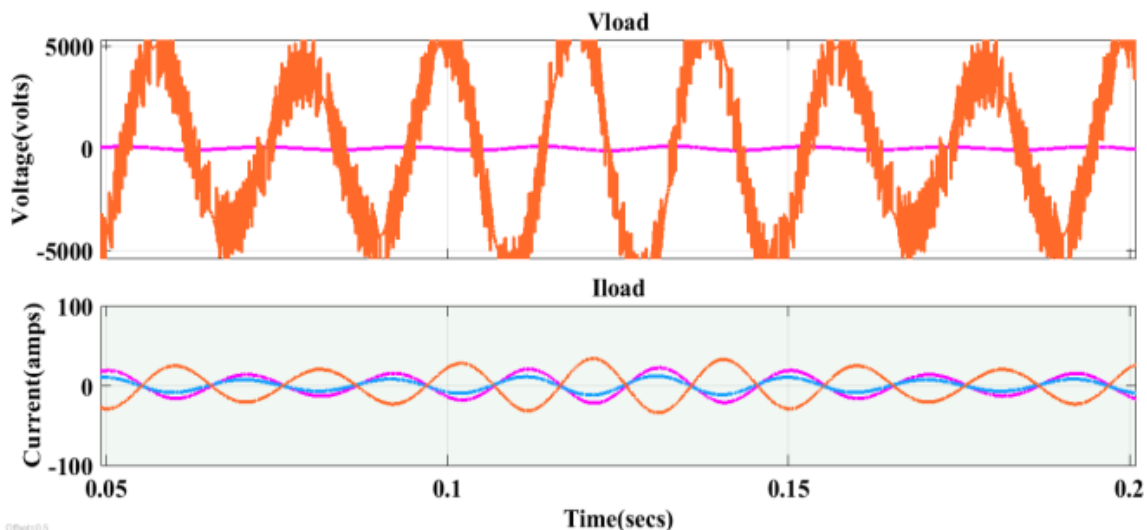

**Fig.8.** MMC based STATCOM with Double LG fault

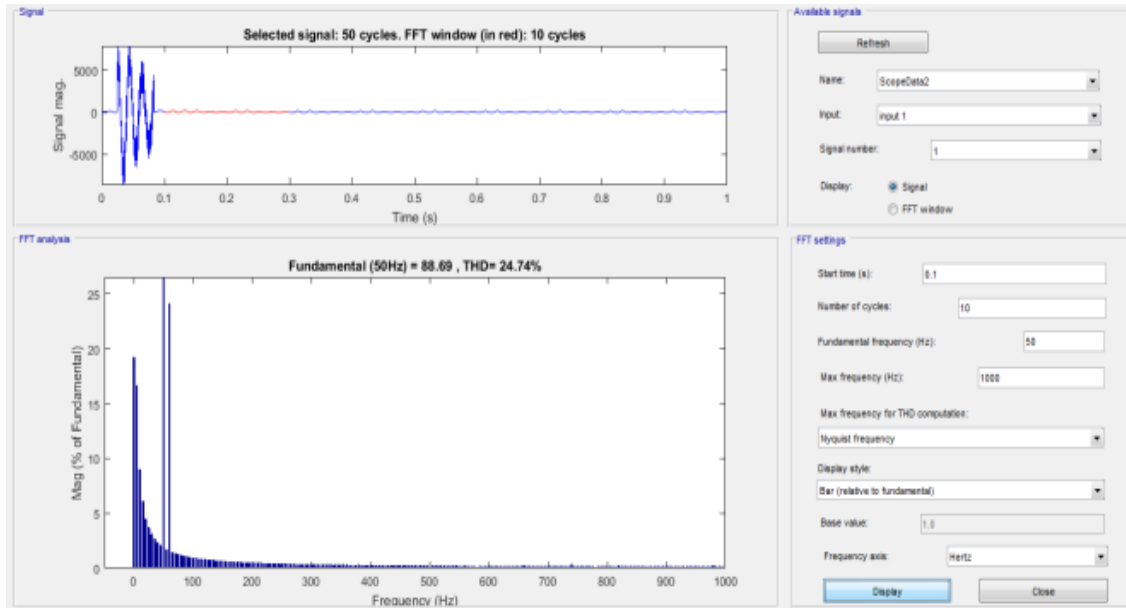

Fig.9. THD of MMC based STATCOM with Double LG fault.

Modular Multilevel converter based STATCOM with Double LG fault is as shown in the above figure 8 & 9 as due to the Double LG fault the output has only one phase and the two phases are passing through the origin and the respective total harmonic distortion of Double LG fault is 24.74%.

**Triple LG Fault:**

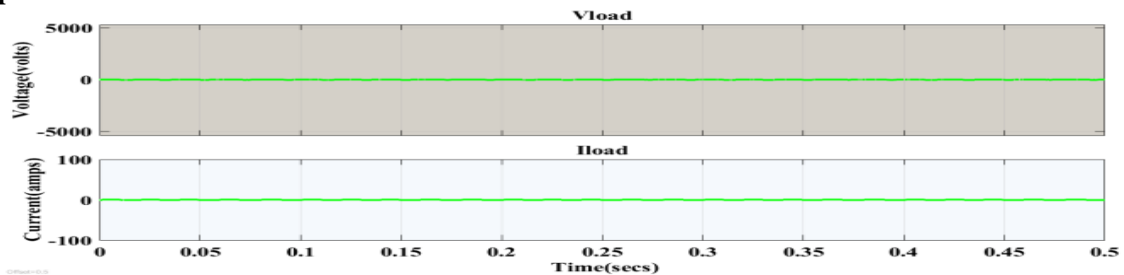

Fig.10. MMC based STATCOM with Triple LG fault

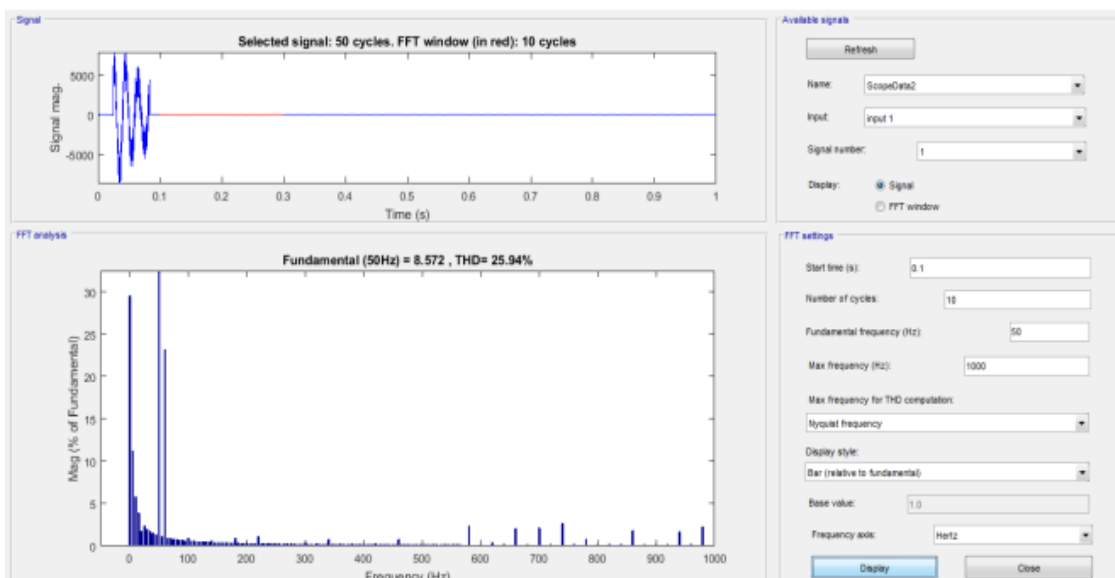

Fig.11. Total harmonic distortion of MMC based STATCOM with triple LG fault.

Modular Multilevel converter based STATCOM with Triple LG fault is as shown in the above figure 10 & 11 as due to the Triple LG fault the output all the three phases are passing through the origin and the respective total harmonic distortion of Triple LG fault is 25.94%.

**Double L Fault:**

Modular Multilevel converter based STATCOM with Double L fault is as shown in the above figure 12 & 13 as due to the Double L fault the output has only two phases and the respective total harmonic distortion of Double L fault is 43.81%.

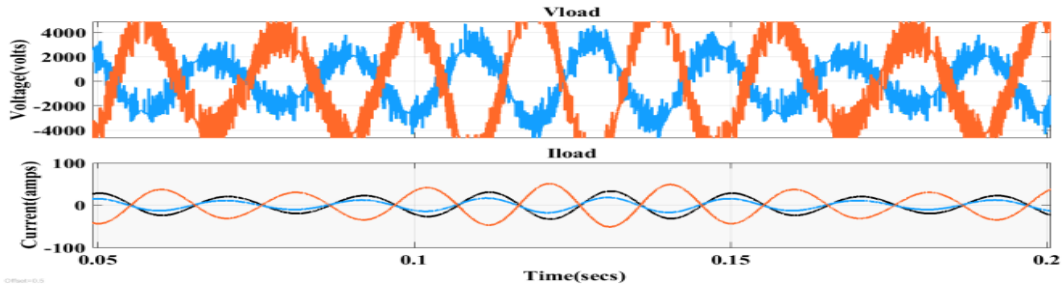

Fig.12. MMC based STATCOM with Double L fault

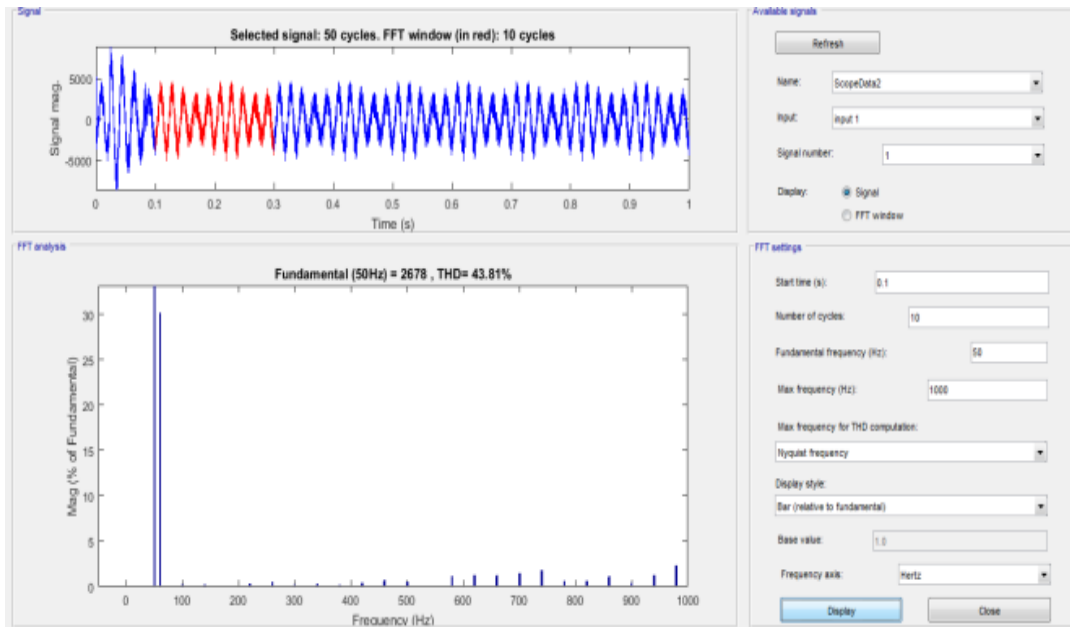

Fig.13. Total harmonic distortion of MMC based STATCOM with Double L fault.

**Triple L fault:**

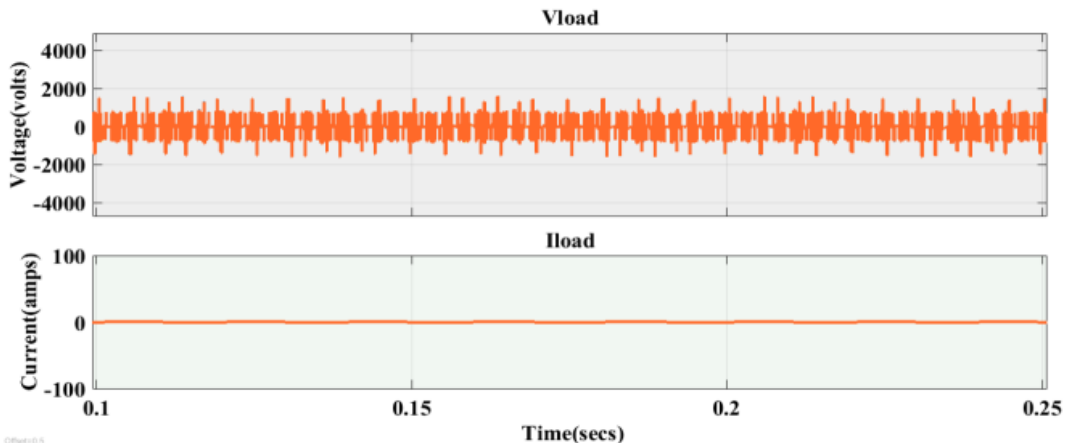

Fig.14. MMC based STATCOM with Triple L fault

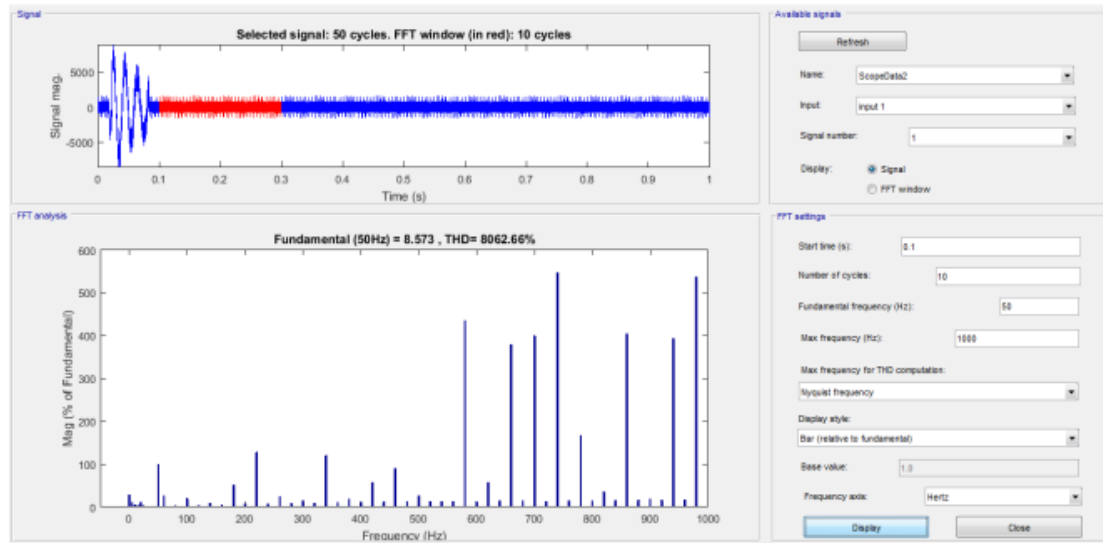

Fig.15. Total harmonic distortion of MMC based STATCOM with triple L fault.

Modular Multilevel converter based STATCOM with Triple L fault is as shown in the above figure 14 & 15 as due to the Triple L fault all the three phases are interconnected and passing through the origin and the respective total harmonic distortion of Triple L fault is 80862.66%.

**Comparison of Different faults and Total Harmonic Distortion:**

Table shows that for different types of faults how will be the total harmonic distortion.

TYPE OF FAULT	THD
LG FAULT	23.70%
LLG FAULT	24.74%
LLLG FAULT	25.94%
LL FAULT	43.81%
LLL FAULT	80862.66%

**VI. Conclusion**

MMC based STATCOM is capable of controlling and balancing all DC mean voltages even during transient states, reactive compensation, total harmonic distortions, simultaneous load balancing. With an increased number of levels MMC is capable of eliminating the coupling transformer and by replacing it with cheap reactors in order to allow power exchange with the power system. In addition to these it can operate continuously even under unbalanced condition. Modularity characteristics of MMC based STATCOM increases its reliability which results as it is suitable for high power applications such as electrified railway power system.

**References**

- [1] A. Lesnicar and R. Marquardt, "An innovative modular multilevel converter topology suitable for a wide power range," in Power Tech Conference Proceedings, 2003 IEEE Bologna, 2003, p. 6 pp. Vol.3.
- [2] R. Baker and L. Bannister. Electric power converter, Patent US 3867643, 1975.
- [3] F.Z. Peng, J.-S. Lai, J.W. McKeever, and J. Van Coevering. A multilevel voltage source inverter with separate DC sources for static VAR generation. IEEE Transactions on Industry Applications, 32(5):pp. 1130–1138, Sep./Oct. 1996.
- [4] Wikipedia. The free encyclopedia. Hvdc converter, jan 2015.
- [5] JianzhongXu; Chengyong Zhao; Wenjing Liu; ChunyiGuo, "Accelerated Model of Modular Multilevel Converters in PSCAD/EMTDC," Power Delivery, IEEE Transactions on , vol.28, no.1, pp.129,136, Jan. 2013.
- [6] Jiangchao Qin and Maryam Saeedifard "Reduced Switching-Frequency Voltage-BalancingStrategies for Modular Multilevel HVDC Converters," IEEE Transactions on Power Delivery, Vol. 28, No. 4, October 2013.
- [7] Ryan Blackmon"Analysis of Modulation and Voltage Balancing Strategies for Modular Multilevel Converters" University of South Carolina, 2013.
- [8] Amankwah, E.K.; Clare, J.C.; Wheeler, P.W.; Watson, A.J., "Multi carrier PWM of the modular multilevel VSC for medium voltage applications," Applied Power Electronics Conference and Exposition (APEC), 2012 Twenty-Seventh Annual IEEE , vol., no., pp.2398,2406, 5-9 Feb. 2012



- [9] L. Angquist, A. Antonopoulos, D. Siemazko, K. Ilves, M. Vasiladiotis, and H.-P. Nee, "Open-loop control of modular multilevel converters using estimation of stored energy," *IEEE Trans. Ind. Appl.*, vol. 47, no. 6, pp. 2516–2524, Nov./Dec. 2011.
- [10] S. Rohner, S. Bernet, M. Hiller, and R. Sommer, "Modulation, losses, and semiconductor requirements of modular multilevel converters," *IEEE Trans. Ind. Electron.*, vol. 57, no. 8, pp. 2633–2642, Aug. 2010.
- [11] J. Qin and M. Saeedifard, "Predictive control of a modular multilevel converter for a back-to-back HVDC system," *IEEE Trans. Power Del.*, vol. 27, no. 3, pp. 1538–1547, Jul. 2012.
- [12] M. Hagiwara and H. Akagi, "Control and experiment of pulse width modulated modular multilevel converters," *IEEE Trans. Power Electron.*, vol. 24, no. 7, pp. 1737–1746, Jul. 2009.
- [13] Q. Tu, Z. Xu, and L. Xu, "Reduced switching-frequency modulation and circulating current suppression for modular multilevel converters," *IEEE Trans. Power Del.*, vol. 26, no. 3, pp. 2009–2017, Jul. 2011.
- [14] M. Hagiwara and H. Akagi, "Control and analysis of the modular multilevel cascade converter based on double-star chopper-cells (MMCCDSCC)," *IEEE Trans. Power Electron.*, vol. 26, no. 6, pp. 1649–1658, Jun. 2011.
- [15] S. Du, J. Liu, and J. Lin, "Leg-balancing control of the DC-link voltage for modular multilevel converters," *Power Electron.*, vol. 12, no. 5, pp. 739–747, 2012.
- [16] E. Solas, G. Abad, J. Barrena, S. Aurtenetxea, A. Carcar, and L. Zajac, "Modular multilevel converter with different submodule concepts—Part I: Capacitor voltage balancing method," *IEEE Trans. Ind. Electron.*, vol. 60, no. 10, pp. 4525–4535, Oct. 2013.
- [17] E. Solas, G. Abad, J. Barrena, S. Aurtenetxea, A. Carcar, and L. Zajac, "Modular multilevel converter with different submodule concepts—Part II: Experimental validation and comparison for HVDC application," *IEEE Trans. Ind. Electron.*, vol. 60, no. 10, pp. 4536–4545, Oct. 2013.
- [18] Q. Tu and Z. Xu, "Impact of sampling frequency on harmonic distortion for modular multilevel converter," *IEEE Trans. Power Del.*, vol. 26, no. 1, pp. 298–306, Jan. 2011.
- [19] K. Ilves, A. Antonopoulos, S. Norrga, and H.-P. Nee, "A new modulation method for the modular multilevel converter allowing fundamental switching frequency," *IEEE Trans. Power Electron.*, vol. 27, no. 8, pp. 3482–3494, Aug. 2012.
- [20] Z. Li, P. Wang, H. Zhu, Z. Chu, and Y. Li, "An improved pulse width modulation method for chopper-cell-based modular multilevel converters," *IEEE Trans. Power Electron.*, vol. 27, no. 8, pp. 3472–3481, Aug. 2012.
- [21] M. Saeedifard and R. Irvani, "Dynamic performance of a modular multilevel back-to-back HVDC system," *IEEE Trans. Power Del.*, vol. 25, no. 4, pp. 2903–2912, Oct. 2010.
- [22] S. Kouro, M. Malinowski, K. Gopakumar, J. Pou, L. G. Franquelo, B. Wu, J. Rodriguez, M. A. Perez, and J. I. Leon, "Recent advances and industrial applications of multilevel converters," *IEEE Trans. Ind. Electron.*, vol. 57, no. 8, pp. 2553–2580, Aug. 2010.
- [23] D. G. Holmes and B. P. McGrath, "Opportunities for harmonic cancellation with carrier-based PWM for a two-level and multilevel cascaded inverters," *IEEE Trans. Ind. Appl.*, vol. 37, no. 2, pp. 574–582, Mar./Apr. 2001.
- [24] R. Naderi and A. Rahmati, "Phase-shifted carrier PWM technique for general cascaded inverters," *IEEE Trans. Power Electron.*, vol. 23, no. 3, pp. 1257–1269, May. 2008.
- [25] C. K. Lee, J. S. K. Leung, S. Y. R. Hui, H. S. H. Chung, "Circuit-level comparison of STATCOM technologies," *IEEE Transactions on Power Electronics*, Vol. 18, No. 4, pp. 1084–1092, Jul. 2003.
- [26] Fang Z. Peng, John Wang, McKeever, Donald J. Adams, "A power line conditioner using cascade multilevel inverters for distribution systems," *IEEE Transactions on Industrial Application*, Vol. 34, No. 6, pp. 1293–1298, Nov./Dec. 1998.
- [27] Y. M. Park, H. S. Ryu, H. W. Lee, M. G. Jung, S. H. Lee, "Design of a cascaded H-Bridge multilevel inverter based on power electronics building blocks and control for high performance," *Journal of Power Electronics*, Vol. 10, No. 3, pp. 262–269, Mar. 2010.
- [28] H. I. Eini, S. Farhangi, J. L. Schanen, M. K. Fard, "A fault-tolerant control strategy for cascaded h-bridge multilevel rectifiers," *Journal of Power Electronics*, Vol. 10, No. 1, pp. 34–42, Jan. 2010.
- [29] G. K. Kasal, B. Singh, "H-bridge VSC with a t-connected transformer for a 3-phase 4-wire voltage and frequency controller of an isolated asynchronous generator," *Journal of Power Electronics*, Vol. 9, No. 1, pp. 43–50, Jan. 2009.
- [30] H. Akagi, S. Inoue, T. Yoshii, "Control and performance of a transformer less cascade PWM STATCOM with star configuration," *IEEE Transactions on Industry Applications*, Vol. 43, No. 4, pp. 1041–1049, Jul./Aug. 2007.
- [31] Fang Z. Peng, Jin Wang, "A universal STATCOM with delta-connected cascade multilevel inverter," *IEEE PESC'04*, Jun. 2004.
- [32] R. E. Betz, T. Summerst, T. Furney, "Using a cascaded h-bridge STATCOM for rebalancing unbalanced voltages," *The 7th International Conference on Power Electronics*, 2007.
- [33] R. E. Betz, T. Summers, and T. Furney, "Symmetry compensation using a H-bridge multilevel STATCOM with zero sequence injection," *IEEE Industry Applications Conference*, Oct. 2006.
- [34] R. Marquardt, "Stromrichters chaltungen mit verteilten energiespeichern," *German Patent DE 10 103 031*, Jan. 24, 2001.
- [35] M. Hiller, D. Krug, R. Sommer, S. Rohner, "A new highly modular medium voltage converter topology for industrial drive applications," *13th European Conference on Power Electronics and Applications*, 2009.